

GRES FINE PORCELLANATO

GEOBRICK



GEOBRICK

Geobrick è la nuova, completa e versatile collezione di pavimenti in gres fine porcellanato che Monocibec dedica alla progettazione di tutti gli spazi interni ed esterni. Geobrick declina le sensazioni materiche e cromatiche del cotto tradizionale attraverso una finitura naturale, per creare ambienti eleganti e accoglienti, e una finitura grip a 9 e 20 mm di spessore, che favorisce l'utilizzo delle aree outdoor anche in condizioni climatiche non ideali, limitando il rischio di scivolamenti.

Geobrick is Monocibec's complete, versatile new collection of fine porcelain floor coverings for indoor and outdoor use. Geobrick expresses all the material and chromatic sensations of traditional terra cotta, with a natural finish for elegant, cosy spaces and a grip finish for outdoor use in 9 and 20 mm thickness, to prevent slipping even in inclement weather.

GEOBRICK

OUTDOOR

1 SUPERFICIE / SURFACE . **GRIP** / GRIP
2 BORDI / EDGES . **NATURALE** / NATURAL **RETTIFICATO** / RECTIFIED
6 FORMATI / SIZES

10 mm

MAJOR 20 mm



50x50 cm - 20"x20"
25x50 cm - 10"x20"
25x25 cm - 10"x10"
6,2x25 cm - 2,4"x10"

80x80 cm - 31,5"x31,5"
60x60 cm - 24"x24"



50x50 cm - 20"x20"
25x50 cm - 10"x20"
25x25 cm - 10"x10"
6,2x25 cm - 2,4"x10"

80x80 cm - 31,5"x31,5"
60x60 cm - 24"x24"



50x50 cm - 20"x20"
25x50 cm - 10"x20"
25x25 cm - 10"x10"
6,2x25 cm - 2,4"x10"

80x80 cm - 31,5"x31,5"
60x60 cm - 24"x24"



50x50 cm - 20"x20"
25x50 cm - 10"x20"
25x25 cm - 10"x10"
6,2x25 cm - 2,4"x10"

80x80 cm - 31,5"x31,5"
60x60 cm - 24"x24"



6,2x25 cm - 2,4"x10"

80x80 cm - 31,5"x31,5"
60x60 cm - 24"x24"

GEOBRICK

INDOOR

1 SUPERFICIE / SURFACE . **NATURALE** / NATURAL
1 BORDO / EDGE . **RETTIFICATO** / RECTIFIED
3 FORMATI / SIZES

9 mm



60x60 cm - 24"x24"
30x60 cm - 12"x24"
30x30 cm - 12"x12"



60x60 cm - 24"x24"
30x60 cm - 12"x24"
30x30 cm - 12"x12"



60x60 cm - 24"x24"
30x60 cm - 12"x24"
30x30 cm - 12"x12"



60x60 cm - 24"x24"
30x60 cm - 12"x24"
30x30 cm - 12"x12"



60x60 cm - 24"x24"
30x60 cm - 12"x24"
30x30 cm - 12"x12"

BRUGES

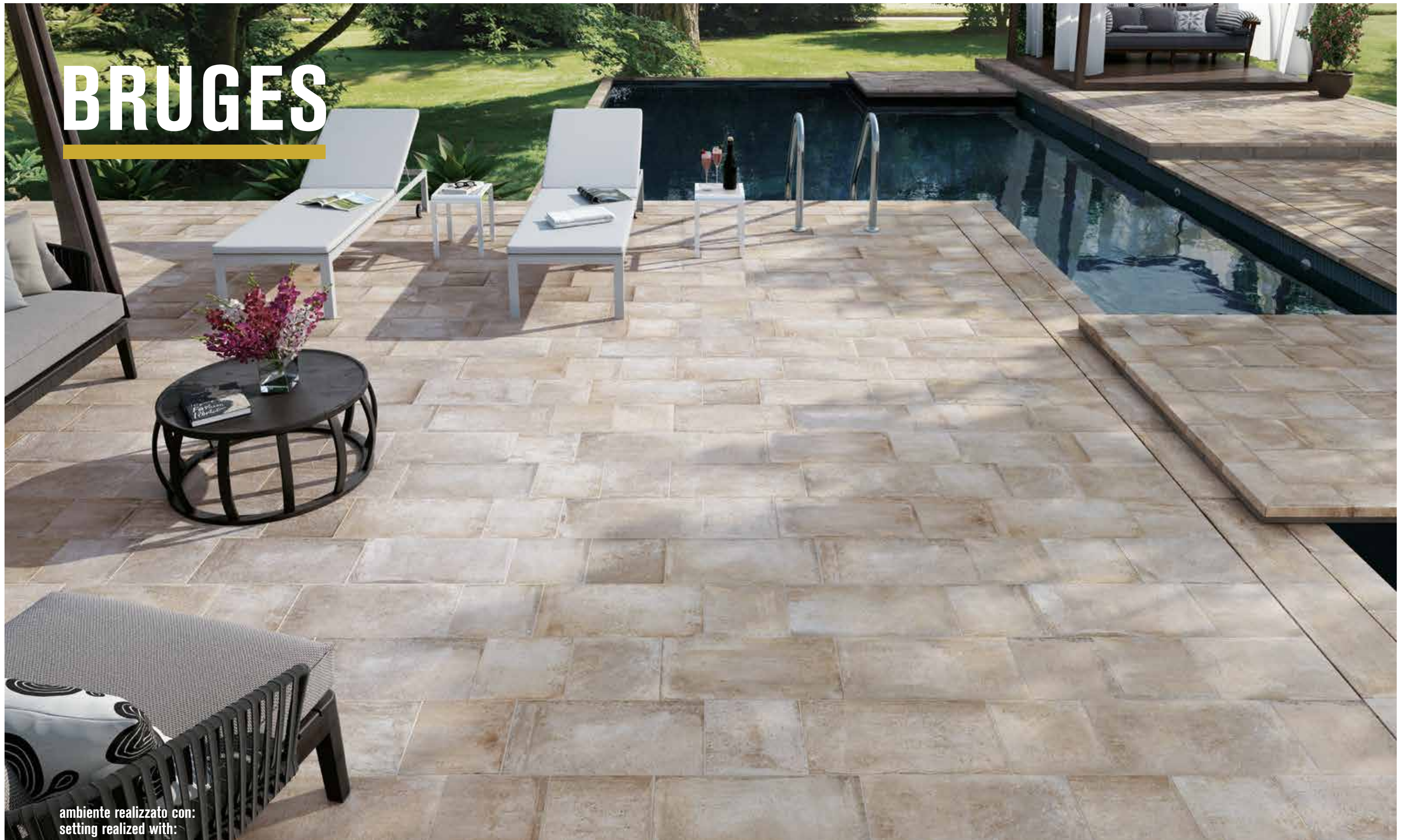

ambiente realizzato con:
setting realized with:

bruges 25x50 grip
bruges 25x25 grip
pezzi speciali pools&wellness / pools&wellness special pieces





VOLTERRA



ambiente realizzato con:
setting realized with:

volterra 25x50 grip
volterra mattoncino 6,2x25 grip

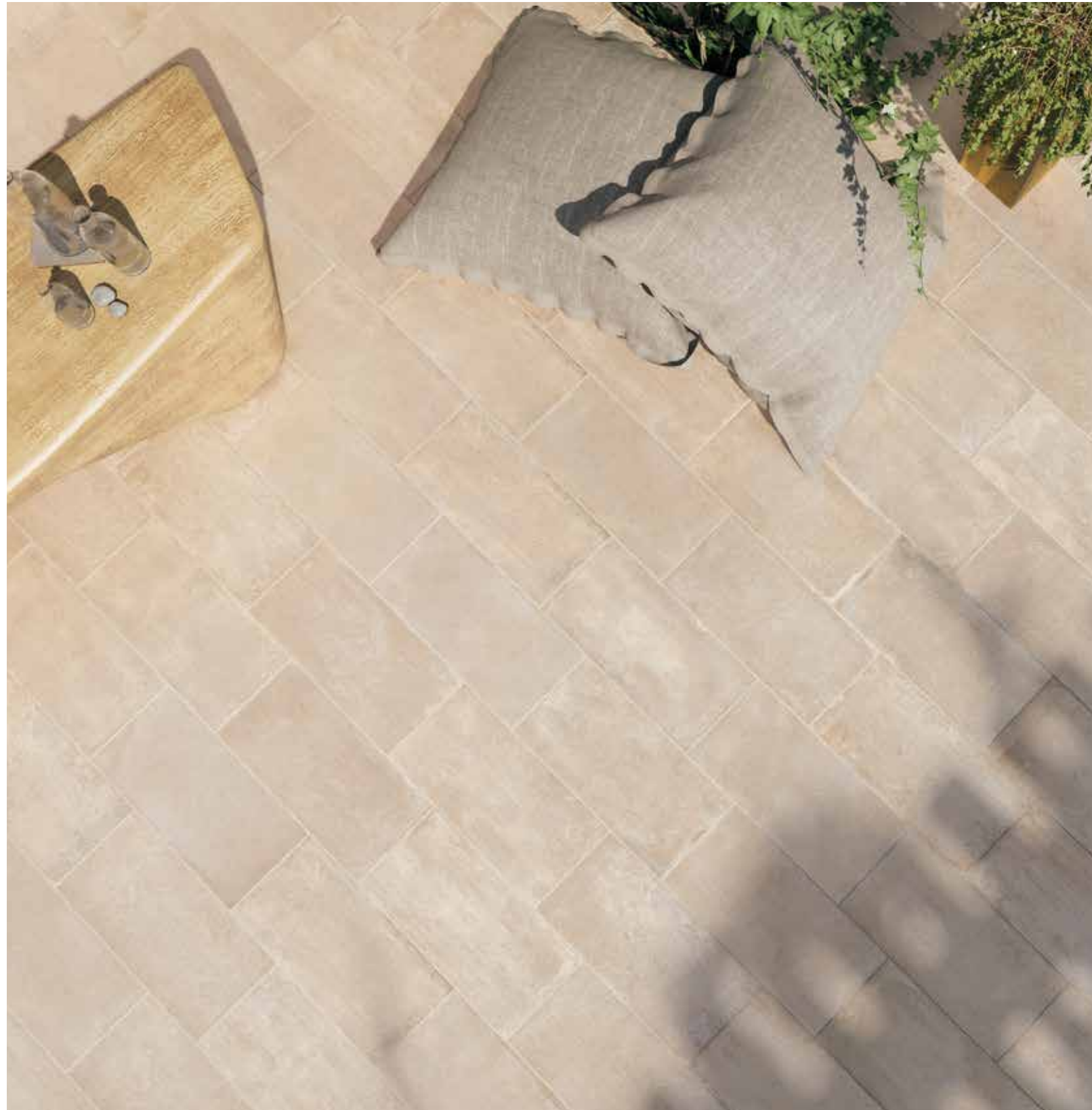



SIENA



ambiente realizzato con:
setting realized with:

siena 50x50 grip
siena 25x50 grip
siena mattoncino 6,2x25 grip





CANOSSA



ambiente realizzato con:
setting realized with:

canossa 25x50 grip
canossa mattoncino 6,2x25 grip

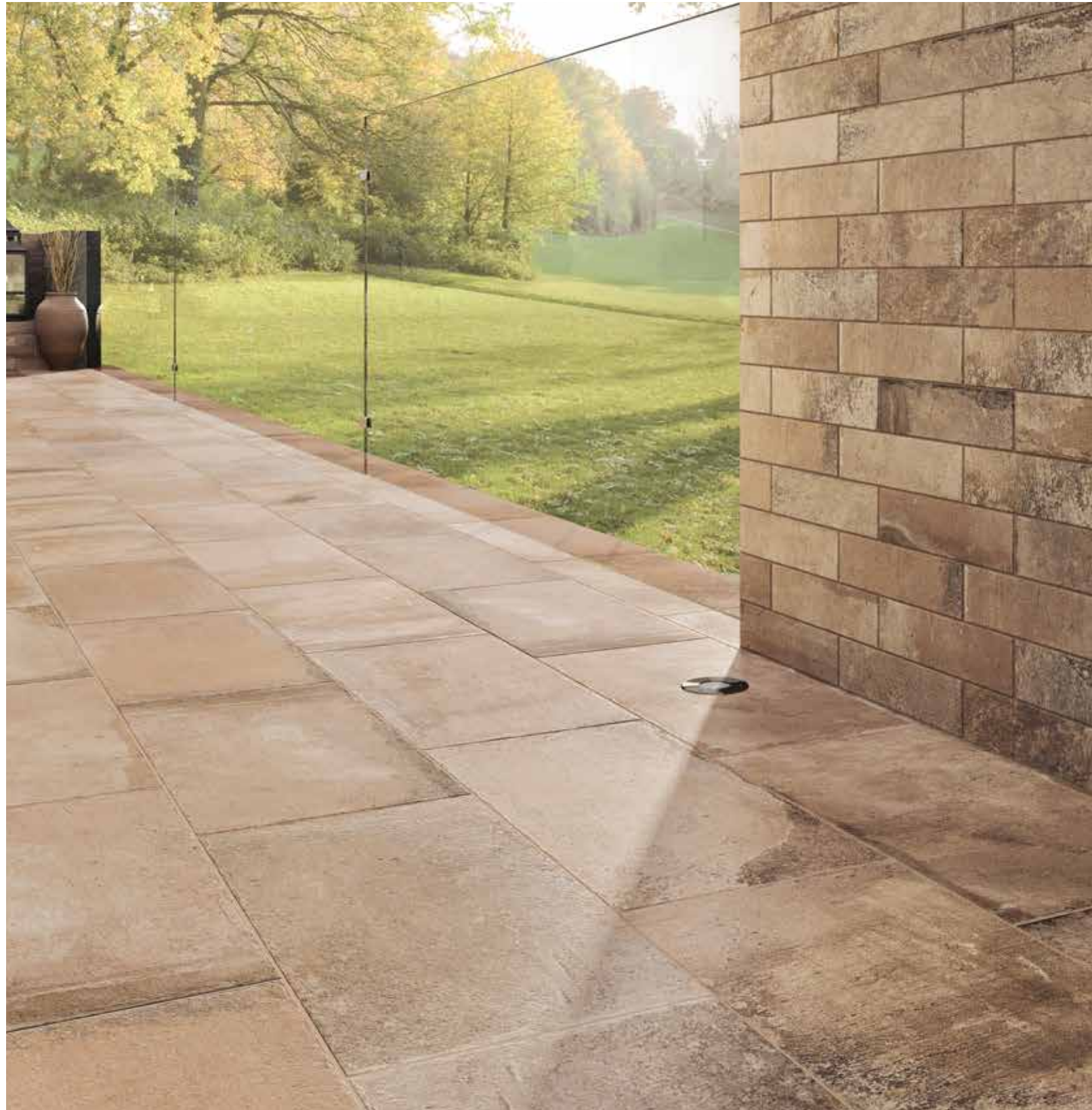

24

CANOSSA



25





GRONINGEN



ambiente realizzato con:
setting realized with:

groningen 60x60 naturale

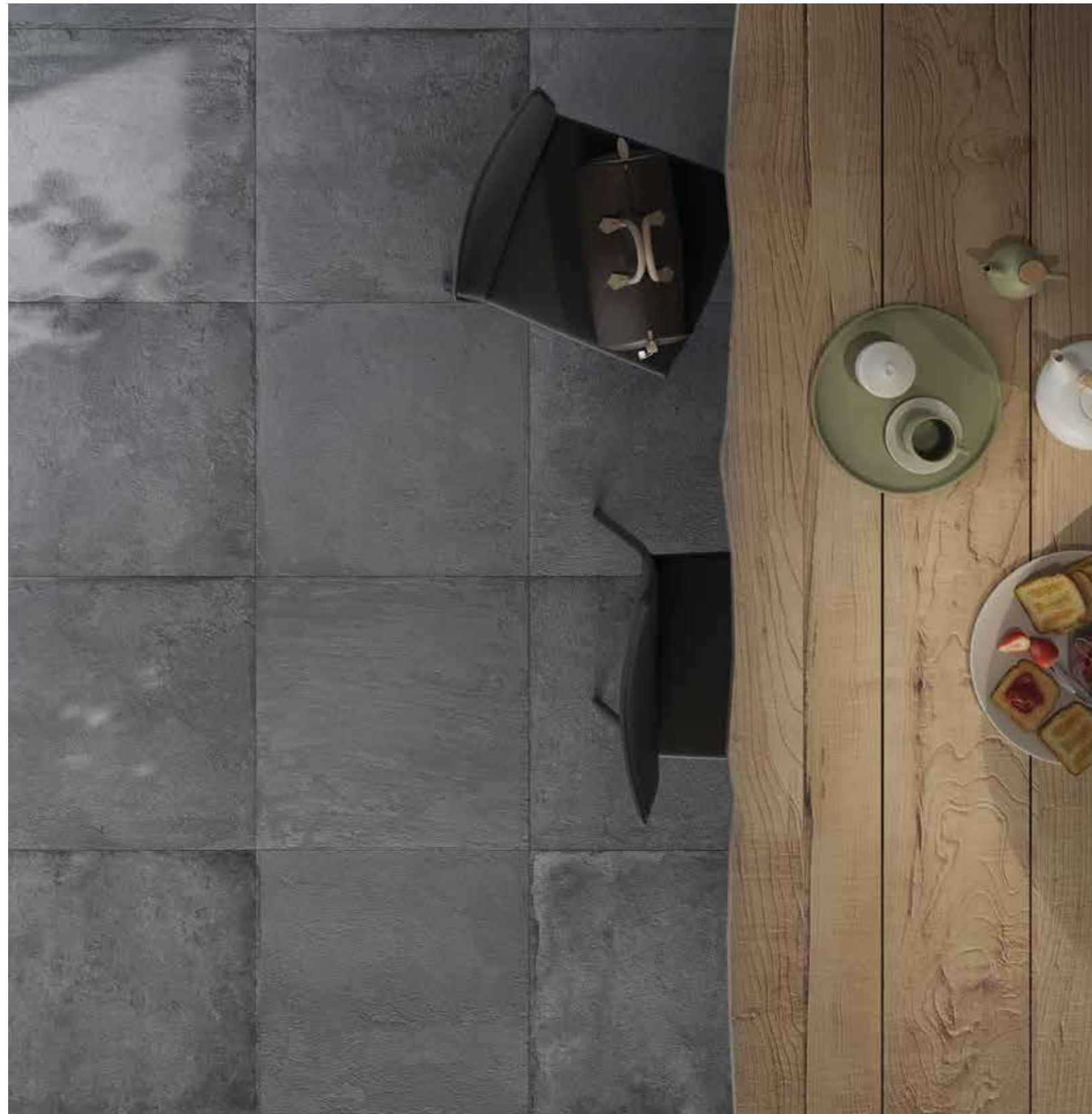



OUTDOOR



BRUGES **VOLTERRA** **SIENA** **CANOSSA**

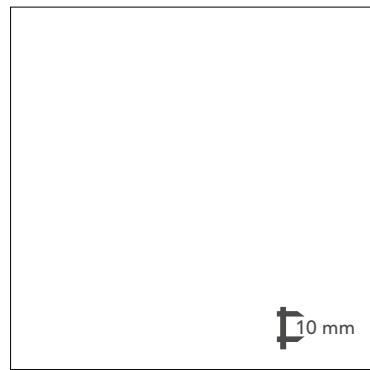

50x50 . 20"x20" Grip
94846 Bruges
94845 Volterra
94844 Siena
94843 Canossa

■ 83

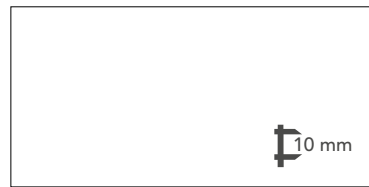

25x50 . 10"x20" Grip
94850 Bruges
94849 Volterra
94848 Siena
94847 Canossa

■ 83

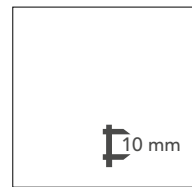

25x25 . 10"x10" Grip
94854 Bruges
94853 Volterra
94852 Siena
94851 Canossa

■ 83



Mattoncino 6,2x25 . 2,4"x10" Grip
96148 Bruges
96151 Volterra
96150 Siena
96149 Canossa
101867 Groningen

■ 141

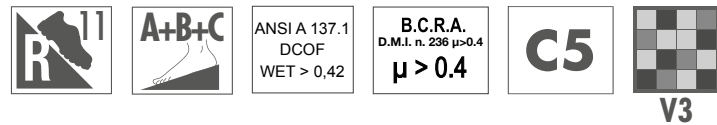

BRUGES **VOLTERRA** **SIENA** **CANOSSA** **GRONINGEN**

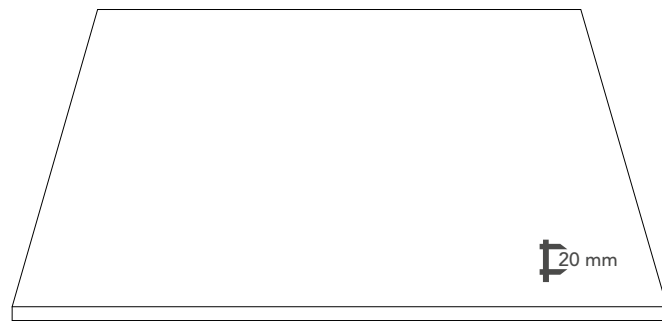

80x80 . 31,5"x31,5" Nat. rett.
107666 Bruges 107665 Canossa
107668 Volterra 107669 Groningen
107667 Siena

■ 168



60x60 . 24"x24" Nat. rett.
107651 Bruges 107650 Canossa
107653 Volterra 107654 Groningen
107652 Siena

■ 151

INDOOR



BRUGES **VOLTERRA** **SIENA** **CANOSSA** **GRONINGEN**



60x60 . 24"x24" Nat. rett.
100687 Bruges
100690 Volterra
100689 Siena
100688 Canossa
100686 Groningen

■ 105

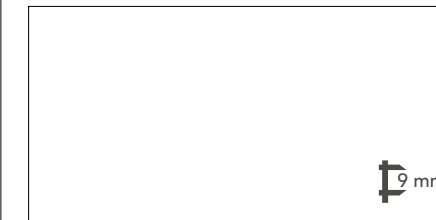

30x60 . 12"x24" Nat. rett.
100692 Bruges
100695 Volterra
100694 Siena
100693 Canossa
100691 Groningen

■ 89



30x30 . 12"x12" Nat. rett.
100697 Bruges
100700 Volterra
100699 Siena
100698 Canossa
100696 Groningen

■ 109

GEOBRICK

OUTDOOR

PEZZI SPECIALI . SPECIAL PIECES

10 mm



8x50 . 3"x20" BATTISCOPA GRIP ● 14
 25x50 . 10"x20" GRADINO GRIP ● 43
 15x30x4 . 6"x12"x1,6" ELEMENTO ELLE MONOLITICO GRIP ● 31

PEZZI SPECIALI . SPECIAL PIECES

20 mm

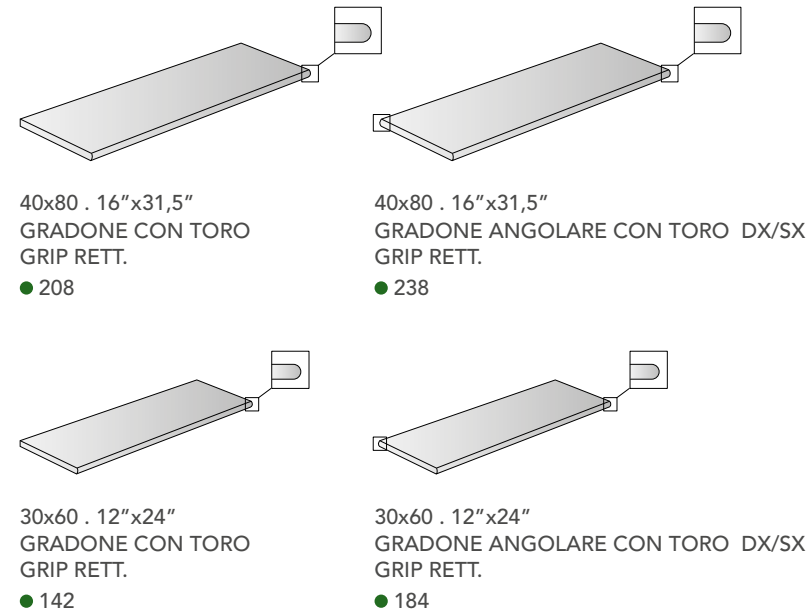

40x80 . 16"x31,5" GRADONE CON TORO GRIP RETT. ● 208
 40x80 . 16"x31,5" GRADONE ANGOLARE CON TORO DX/SX GRIP RETT. ● 238
 30x60 . 12"x24" GRADONE CON TORO GRIP RETT. ● 142
 30x60 . 12"x24" GRADONE ANGOLARE CON TORO DX/SX GRIP RETT. ● 184

INDOOR

PEZZI SPECIALI . SPECIAL PIECES

9 mm

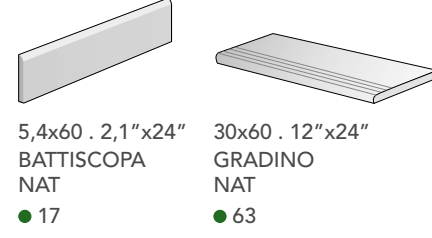

5,4x60 . 2,1"x24" BATTISCOPA NAT ● 17
 30x60 . 12"x24" GRADINO NAT ● 63

PEZZI SPECIALI POOLS&WELLNESS . POOLS&WELLNESS SPECIAL PIECES

10 mm

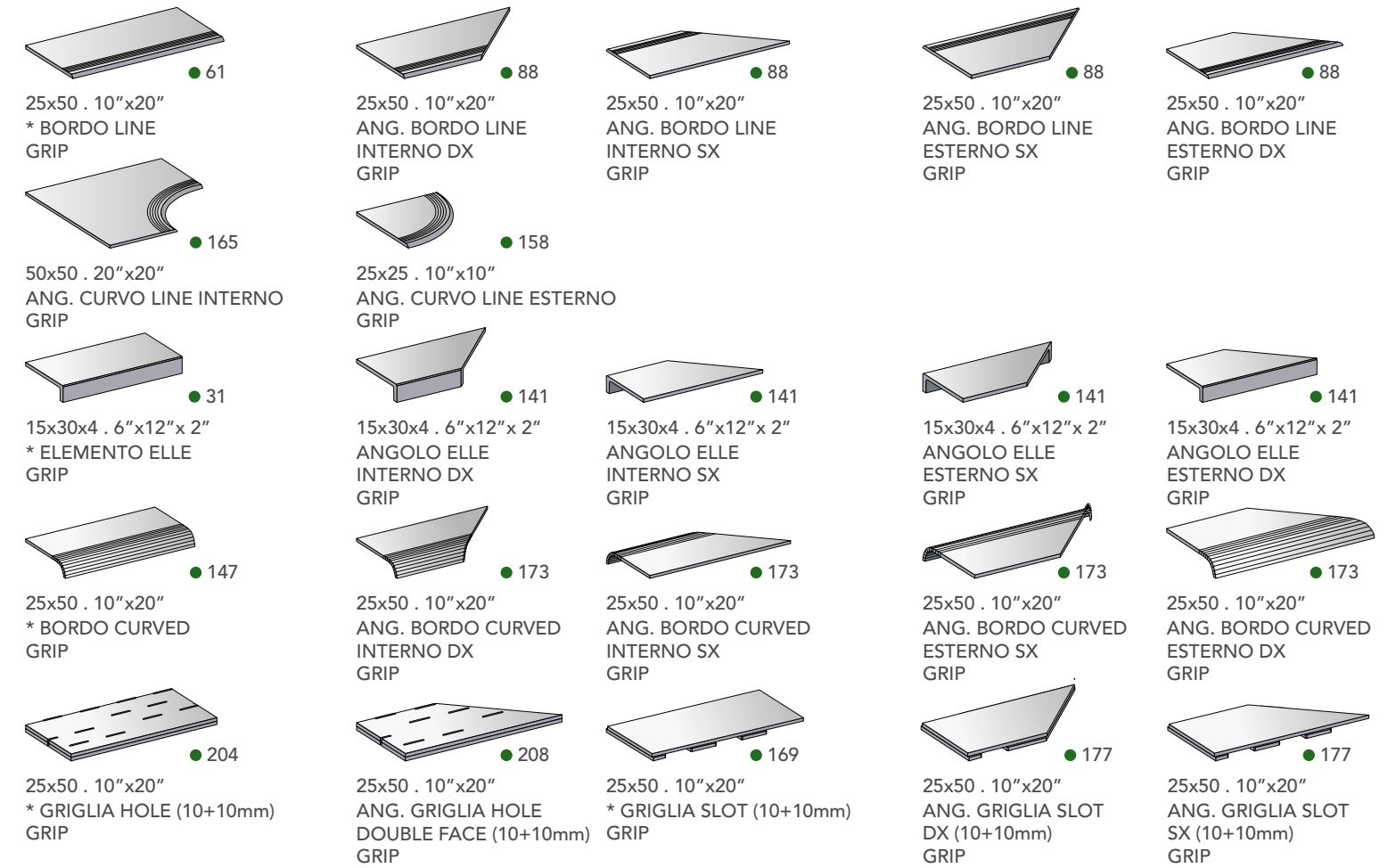

25x50 . 10"x20" * BORDO LINE GRIP ● 61
 25x50 . 10"x20" ANG. BORDO LINE INTERNO DX GRIP ● 88
 25x50 . 10"x20" ANG. BORDO LINE INTERNO SX GRIP ● 88
 25x50 . 10"x20" ANG. BORDO LINE ESTERNO SX GRIP ● 88
 25x50 . 10"x20" ANG. BORDO LINE ESTERNO DX GRIP ● 88
 50x50 . 20"x20" ANG. CURVO LINE INTERNO GRIP ● 165
 25x25 . 10"x10" ANG. CURVO LINE ESTERNO GRIP ● 158
 15x30x4 . 6"x12"x2" * ELEMENTO ELLE GRIP ● 31
 15x30x4 . 6"x12"x2" ANGOLO ELLE INTERNO DX GRIP ● 141
 15x30x4 . 6"x12"x2" ANGOLO ELLE INTERNO SX GRIP ● 141
 15x30x4 . 6"x12"x2" ANGOLO ELLE ESTERNO SX GRIP ● 141
 15x30x4 . 6"x12"x2" ANGOLO ELLE ESTERNO DX GRIP ● 141
 25x50 . 10"x20" * BORDO CURVED GRIP ● 147
 25x50 . 10"x20" ANG. BORDO CURVED INTERNO DX GRIP ● 173
 25x50 . 10"x20" ANG. BORDO CURVED INTERNO SX GRIP ● 173
 25x50 . 10"x20" ANG. BORDO CURVED ESTERNO SX GRIP ● 173
 25x50 . 10"x20" ANG. BORDO CURVED ESTERNO DX GRIP ● 173
 25x50 . 10"x20" * GRIGLIA HOLE (10+10mm) GRIP ● 204
 25x50 . 10"x20" ANG. GRIGLIA HOLE DOUBLE FACE (10+10mm) GRIP ● 208
 25x50 . 10"x20" * GRIGLIA SLOT (10+10mm) GRIP ● 169
 25x50 . 10"x20" ANG. GRIGLIA SLOT DX (10+10mm) GRIP ● 177
 25x50 . 10"x20" ANG. GRIGLIA SLOT SX (10+10mm) GRIP ● 177



20 mm

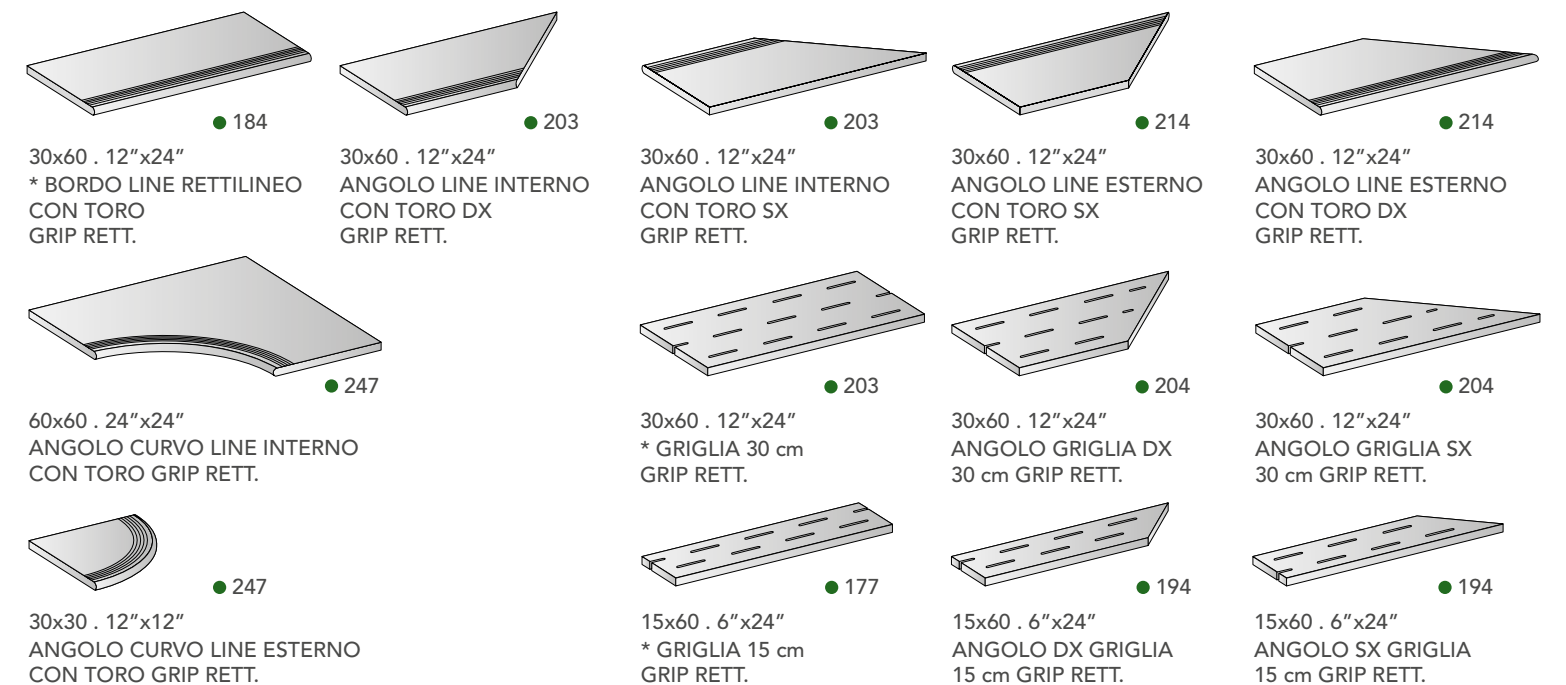

30x60 . 12"x24" * BORDO LINE RETTILINEO CON TORO GRIP RETT. ● 184
 30x60 . 12"x24" ANGOLO LINE INTERNO CON TORO DX GRIP RETT. ● 203
 30x60 . 12"x24" ANGOLO LINE INTERNO CON TORO SX GRIP RETT. ● 203
 30x60 . 12"x24" ANGOLO LINE ESTERNO CON TORO SX GRIP RETT. ● 214
 30x60 . 12"x24" ANGOLO LINE ESTERNO CON TORO DX GRIP RETT. ● 214
 60x60 . 24"x24" ANGOLO CURVO LINE INTERNO CON TORO GRIP RETT. ● 247
 30x60 . 12"x24" * GRIGLIA 30 cm GRIP RETT. ● 203
 30x60 . 12"x24" ANGOLO GRIGLIA DX 30 cm GRIP RETT. ● 204
 30x60 . 12"x24" ANGOLO GRIGLIA SX 30 cm GRIP RETT. ● 204
 30x30 . 12"x12" ANGOLO CURVO LINE ESTERNO CON TORO GRIP RETT. ● 247
 15x60 . 6"x24" * GRIGLIA 15 cm GRIP RETT. ● 177
 15x60 . 6"x24" ANGOLO DX GRIGLIA 15 cm GRIP RETT. ● 194
 15x60 . 6"x24" ANGOLO SX GRIGLIA 15 cm GRIP RETT. ● 194

*Prezzo per ordine minimo di 20 pz. Per quantitativi inferiori, rivolgersi agli uffici commerciali per una quantificazione specifica.
 *Price for a minimum order of 20 items. For smaller volumes, please contact our commercial office for a specific quote.

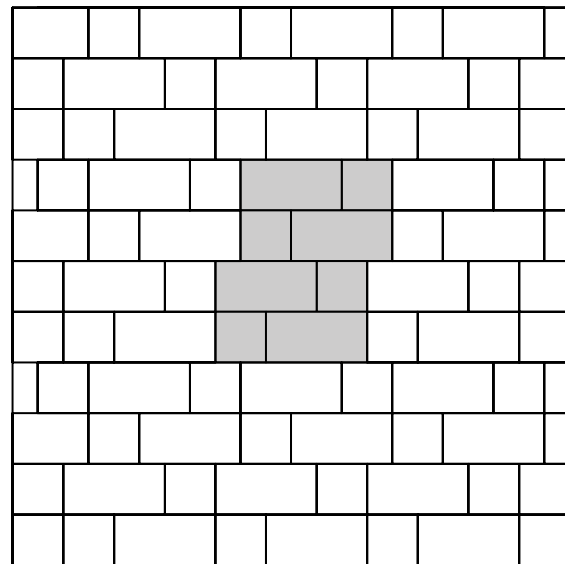

FORMATI - SIZES	% MQ
25x50 . 10"x20"	66,7 %
25x25 . 10"x10"	33,3 %
30x60 . 12"x24"	66,7 %
30x30 . 12"x12"	33,3 %

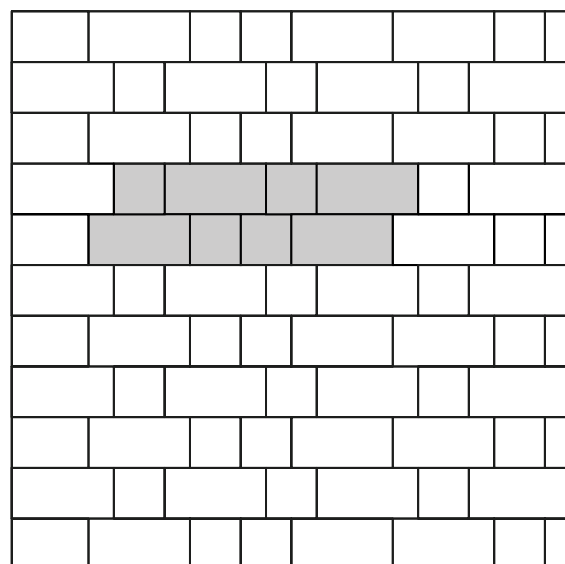

FORMATI - SIZES	% MQ
25x50 . 10"x20"	66,7 %
25x25 . 10"x10"	33,3 %
30x60 . 12"x24"	66,7 %
30x30 . 12"x12"	33,3 %

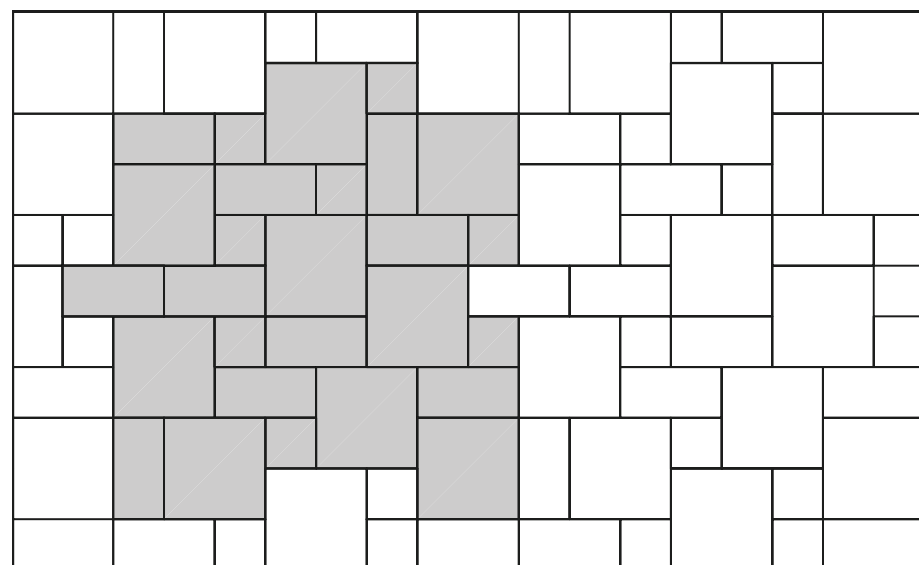

FORMATI - SIZES	% MQ
50x50 . 20"x20"	56,3 %
25x50 . 10"x20"	31,3 %
25x25 . 10"x10"	12,5 %
60x60 . 24"x24"	56,3 %
30x60 . 12"x24"	31,3 %
30x30 . 12"x12"	12,5 %

CATEGORIE D'IMPIEGO . USE CLASSES

- C1** Piastrelle da pavimento consigliate per calpestio leggero
Floor tiles recommended for light pounding
- C2** Piastrelle da pavimento consigliate per calpestio medio-leggero
Floor tiles recommended for medium-light pounding
- C3** Piastrelle da pavimento consigliate per calpestio medio
Floor tiles recommended for medium pounding
- C4** Piastrelle da pavimento consigliate per calpestio medio-pesante
Floor tiles recommended for medium-heavy pounding
- C5** Piastrelle da pavimento consigliate per calpestio intenso
Floor tiles recommended for heavy uses

VARIAZIONI CROMATICHE . COLOURS VARIATIONS



È indispensabile all'atto della posa, prelevare le piastrelle da più confezioni.

It is necessary to take the tiles from several different boxes when laying them.

OUTDOOR

IMBALLI . PACKAGING

	50x50	25x50	25x25	6,2x25	80x80 MAJOR	60x60 MAJOR
Pc.	4	9	17	66	1	2
M ²	1	1,125	1,063	1,023	0,64	0,72
Kg	21	23	21	22,5	29	35
Colli boxes	39	54	66	36	40	30
M ²	39	60,75	70,158	36,828	25,6	21,6
Kg	819	1.242	1.386	810	1160	1050

INDOOR

IMBALLI . PACKAGING

	60x60	30x60	30x30
Pc.	3	6	13
M ²	1,08	1,08	1,17
Kg	22,5	22	22
Colli boxes	40	48	48
M ²	43,2	51,84	56,16
Kg	900	1.056	1.056

NOTE . NOTES

I prodotti possono essere modificati da Fincibec senza preavviso, respingendo ogni responsabilità su possibili danni diretti o indiretti causati da potenziali modifiche. Fincibec reserves the right to modify its products without prior notice and cannot be held liable for direct or indirect damage caused by such modifications.

Verificare sempre la correttezza delle informazioni e dei dati relativi a codici, imballaggi e pesi, consultando il listino prezzi in vigore.



















Always refer to the price list in force to ensure correct information and data on codes, packaging, and weight.

Le tonalità dei colori riportate nel catalogo sono indicative. The colours shades, reported on the catalogue, are indicative.

CARATTERISTICHE TECNICHE / GRES FINE PORCELLANATO COLORATO IN MASSA

TECHNICAL SPECIFICATIONS / FULL-BODY COLOURED PORCELAIN STONEWARE - TECHNISCHE EIGENSCHAFTEN / DURCHGEFÄRBTES FEINSTEINZEUG - CARACTÉRISTIQUES TECHNIQUES / GRÈS FIN CÉRAME COLORÉ EN MASSE - CARACTERÍSTICAS TÉCNICAS / GRES FINO PORCELÁNICO TENIDO EN MASA - ТЕХНИЧЕСКИЕ ХАРАКТЕРИСТИКИ / МЕЛКОЗЕРНИСТЫЙ КЕРАМОГРАНИТ, ОКРАШЕННЫЙ В МАССЕ

STANDARDS : UNI EN 14411 ANNEX G - Bla / UNI EN ISO 13006 ANNEX G - Bla

CARATTERISTICHE TECNICHE TECHNICAL DATA TECHNISCHE DATEN CARACTÉRISTIQUES TECHNIQUES CARACTERÍSTICAS TÉCNICAS ТЕХНИЧЕСКИЕ ХАРАКТЕРИСТИКИ	TIPO DI PROVA STANDARD OF TEST NORME DU TEST TESTNORM TIPO DE PRUEBA ТИП ТЕСТА	VALORI PRESCRITTI DALLE NORME INTERNATIONAL STANDARDS INTERNATIONALE NORMWERTE VALEURS PRÉVUES PAR LES NORMES VALORES PREVISTOS POR LAS NORMAS ПРЕДУКАТОРНЫЕ СТАНДАРТЫ REQUIREMENTS FOR NOMINAL SIZE N		VALORE MEDIO MONOCBEC MONOCBECAVERAGEWALUE MONOCBECMITTELWERT VALEUR MOYEN MONOCBEC VALOR MEDIO MONOCBEC СРЕДНЕЕ ЗНАЧЕНИЕ MONOCBEC	
		7 cm ≤ N ≤ 15 cm	N ≥ 15 cm	GRIP	NAT
 LATI SIDES - SEITEN COTES - CANTOS РАЗМЕРЫ СТОРОН	EN ISO 10545-2	± 0,9 mm	± 0,6% (± 2,0 mm)	CONFORME COMPLYING - ERFÜLLT CONFORME - CONFORME COOBTBCTBYET	
 SPESSORE THICKNESS - DICKE ÉPAISSEUR - ESPESOR ТОЛЩИНА	EN ISO 10545-2	± 0,5 mm	± 5,0% (± 0,5 mm)	CONFORME COMPLYING - ERFÜLLT CONFORME - CONFORME COOBTBCTBYET	
 RETTILINEITÀ DEGLI SPIGOLI STRAIGHTNESS OF SIDES - GERAUINGKEIT DER KANTEN RECTITUDE DES ARÊTES - RECTITUD DE LOS CANTOS - КОСОУТОЛЬНОСТЬ	EN ISO 10545-2	± 0,75 mm	± 0,5% (± 1,5 mm)	CONFORME COMPLYING - ERFÜLLT CONFORME - CONFORME COOBTBCTBYET	
 ORTOGONALITÀ RECTANGULARITY - RECHTWINKLIGKEIT PERPENDICULARITÉ - ORTOGONALIDAD КРИБИЗНА СТОРОН	EN ISO 10545-2	± 0,75 mm	± 0,5% (± 2 mm)	CONFORME COMPLYING - ERFÜLLT CONFORME - CONFORME COOBTBCTBYET	
 PLANARITÀ SURFACE FLATNESS - EBENFLÄCHIGKEIT PLANEITE DE SURFACE - PLANEIDAD КРИБИЗНА ЛИЦЕВОЙ ПОВЕРХНОСТИ	EN ISO 10545-2	± 0,75 mm	± 0,5% (± 2,0 mm)	CONFORME COMPLYING - ERFÜLLT CONFORME - CONFORME COOBTBCTBYET	
 ASSORBIMENTO D'ACQUA WATER ABSORPTION - WASSERAUFNAHME ABSORPTION D'EAU - ABSORCIÓN DE AGUA ВОДПОПОЩЕНИЕ	EN ISO 10545-3	≤ 0,5 %		≤ 0,1 %	
 RESISTENZA ALLA FLESSIONE FLEXION RESISTANCE - BIEGEFESTIGKEIT RESISTANCE A LA FLEXION - RESISTENCIA A LA FLEXIÓN ПРЕДЕЛ ПРОЧНОСТИ ПРИ ИЗГИБЕ	EN ISO 10545-4	S ≥ 1.300 N R ≥ 35 N/mm ²		CONFORME COMPLYING - ERFÜLLT CONFORME - CONFORME COOBTBCTBYET	
 RESISTENZA ALL'URTO IMPACT RESISTANCE - STOSSFESTIGKEIT RESISTANCE AUX CHOCS - RESISTENCIA A LOS GOLPES УДАРНОСТОЙКОСТЬ	EN ISO 10545-5	VALORE DICHIARATO DECLARED VALUE - ANGEGBENER WERT VALEUR DÉCLARÉE - VALOR DECLARADO - ЗАЯВЛЕННОЕ ЗНАЧЕНИЕ		> 0,80	
 RESISTENZA ALL'ABRASIONE ABRASION RESISTANCE - ABRIEBFESTIGKEIT RESISTANCE À L'ABRASION - RESISTENCIA A LA ABRASIÓN ПРОЧНОСТЬ НА ИСТИРАНИЕ	EN ISO 10545-6	≤ 175 mm ³		CONFORME COMPLYING - ERFÜLLT CONFORME - CONFORME COOBTBCTBYET	
 COEFFICIENTE DI DILATAZIONE TERMICA LINEARE COEFFICIENT OF LINEAR THERMAL EXPANSION - LINEARER WÄRMEAUSENDNUNGSKOEFFIZIENT COEFFICIENT DE DILATATION THERMIQUE LINEAIRE - COEFFICIENTE DE DILATACIÓN TÉRMICA LINEAL КОЭФФИЦИЕНТ ЛИНЕЙНОГО ТЕРМИЧЕСКОГО РАСТЯЖЕНИЯ	EN ISO 10545-8	VALORE DICHIARATO DECLARED VALUE - ANGEGBENER WERT VALEUR DÉCLARÉE - VALOR DECLARADO - ЗАЯВЛЕННОЕ ЗНАЧЕНИЕ		α = 6,7 × 10 ⁻⁶ / °C	
 RESISTENZA AGLI SBALZI TERMICI RESISTANCE TO THERMAL SHOCKS - BESTÄNDIGKEIT GEGEN TEMPERATURSCHWANKUNGEN RESISTANCE AUX CHOCS THERMIQUES - RESISTENCIA A LOS CHOQUES TÉRMICOS СТОЙКОСТЬ К ПЕРЕПАДАМ ТЕМПЕРАТУРЫ	EN ISO 10545-9	TEST SUPERATO SECONDO EN ISO 10545-1 TEST PASSED ACCORDING TO - TEST BESTANDEN NACH TEXTE DÉPASSÉ SELON - PRUEBA SUPERADA SEGÚN ИСПЫТАНИЕ ПРОЙДЕНО В СООТВЕТСТВИИ С		NESSUN DANNO NO DAMAGE - KEIN SCHADEN AUCUN DOMMAGE - NINGUN DANO БЕЗ ПОВРЕЖДЕНИЙ	
 DILATAZIONE ALL'UMIDITÀ (IN MMM) MOISTURE EXPANSION (IN MMM) - FEUCHTIGKEITSBEDINGTE AUSDEHNUNG (IN MMM) DILATATION À L'HUMIDITÉ (EN MMM) - DILATACION CON LA HUMEDAD (EN MMM) ВЛАЖНОСТНОЕ РАСТЯЖЕНИЕ (В MMM)	EN ISO 10545-10	VALORE DICHIARATO DECLARED VALUE - ANGEGBENER WERT VALEUR DÉCLARÉE - VALOR DECLARADO - ЗАЯВЛЕННОЕ ЗНАЧЕНИЕ		MAX 0,1 mm / m	
 RESISTENZA AL GELO FROST RESISTANCE - FROSTBESTÄNDIGKEIT RESISTANCE AU GEL - RESISTENCIA AL HIELO МОРОЗОСТОЙКОСТЬ	EN ISO 10545-12	TEST SUPERATO SECONDO EN ISO 10545-1 TEST PASSED ACCORDING TO - TEST BESTANDEN NACH TEXTE DÉPASSÉ SELON - PRUEBA SUPERADA SEGÚN ИСПЫТАНИЕ ПРОЙДЕНО В СООТВЕТСТВИИ С		NESSUN DANNO NO DAMAGE - KEIN SCHADEN AUCUN DOMMAGE - NINGUN DANO БЕЗ ПОВРЕЖДЕНИЙ	
 RESISTENZA AI PRODOTTI CHIMICI USO DOMESTICO E ADDITIVI PER PISCINA RESISTANCE TO HOUSEHOLD AND SWIMMING POOL CHEMICAL PRODUCTS - BESTÄNDIGKEIT GEGEN HAUSHALTSCHEMIKALIEN UND ZUSATZSTOFFE FÜR SWIMMINGPOOLS - RESISTANCE AUX PRODUITS CHIMIQUES USAGE DOMESTIQUE ET ADDITIFS POUR PISCINE - RESISTENCIA A LOS PRODUCTOS QUÍMICOS DE USO DOMÉSTICO Y ADITIVOS PARA PISCINA - СТОЙКОСТЬ К ДЕЙСТВИЮ ВЫСОКИХ ХИМИЧЕСКИХ СРЕДСТВ, ДОБАВКАМ В БАССЕЙНЫ	EN ISO 10545-13	B MIN		CONFORME COMPLYING - ERFÜLLT CONFORME - CONFORME COOBTBCTBYET	
 RESISTENZA A BASSE CONCENTRAZIONI DI ACIDI E ALCALI RESISTANCE TO LOW CONCENTRATIONS OF ACIDS AND ALKALI - BESTÄNDIGKEIT BEI NIEDRIGEN KONZENTRATIONEN VON SÄUREN UND LAUGEN - RESISTANCE À BASSES CONCENTRATIONS D'ACIDES ET ALCALIS - RESISTENCIA A BAJAS CONCENTRACIONES DE ÁCIDOS Y ALCALIS - СТОЙКОСТЬ К ДЕЙСТВИЮ НИЗКИХ КОНЦЕНТРАЦИЙ КИСЛОТ И ЩЕЛОЧЕЙ	EN ISO 10545-13	VALORE DICHIARATO DECLARED VALUE - ANGEGBENER WERT VALEUR DÉCLARÉE - VALOR DECLARADO - ЗАЯВЛЕННОЕ ЗНАЧЕНИЕ		CONFORME COMPLYING - ERFÜLLT CONFORME - CONFORME COOBTBCTBYET	
 RESISTENZA AD ALTE CONCENTRAZIONI DI ACIDI E ALCALI RESISTANCE TO HIGH CONCENTRATIONS OF ACIDS AND ALKALI - BESTÄNDIGKEIT BEI HOHEN KONZENTRATIONEN VON SÄUREN UND LAUGEN - RESISTANCE À HAUTES CONCENTRATIONS D'ACIDES ET ALCALIS - RESISTENCIA A ALTAS CONCENTRACIONES DE ÁCIDOS Y ALCALIS - СТОЙКОСТЬ К ДЕЙСТВИЮ ВЫСОКИХ КОНЦЕНТРАЦИЙ КИСЛОТ И ЩЕЛОЧЕЙ	EN ISO 10545-13	VALORE DICHIARATO DECLARED VALUE - ANGEGBENER WERT VALEUR DÉCLARÉE - VALOR DECLARADO - ЗАЯВЛЕННОЕ ЗНАЧЕНИЕ		CONFORME COMPLYING - ERFÜLLT CONFORME - CONFORME COOBTBCTBYET	
 RESISTENZA ALLE MACCHIE RESISTANCE TO STAINS - FLECKENBESTÄNDIGKEIT RESISTANCE AUX TACHES - RESISTENCIA A LAS MANCHAS УСТОЙЧИВОСТЬ К ПЯТНООБРАЗОВАНИЮ	EN ISO 10545-14	VALORE DICHIARATO DECLARED VALUE - ANGEGBENER WERT VALEUR DÉCLARÉE - VALOR DECLARADO - ЗАЯВЛЕННОЕ ЗНАЧЕНИЕ		CONFORME COMPLYING - ERFÜLLT CONFORME - CONFORME COOBTBCTBYET	
 CESSIONE DI PIOMBO E CADMIO LEAD AND CADMIUM DISCHARGE - ABGABE VON BLEI UND CADMIUM PERTE DE PLOMB ET CADMIUM - CESIÓN DE PLOMO Y CADMIO ВЫДЕЛЕНИЕ СВИНЦА И КАДМИЯ	EN ISO 10545-15	VALORE DICHIARATO DECLARED VALUE - ANGEGBENER WERT VALEUR DÉCLARÉE - VALOR DECLARADO - ЗАЯВЛЕННОЕ ЗНАЧЕНИЕ		< LIMITE DI RILEVAMENTO < THAN INSTRUMENT LIMIT - UNMESSBARES WERT < LIMITE DE L'INSTRUMENT - LIMITE DEL INSTRUMENTO < НА ПРЕДЕЛЕ ОПРЕДЕЛЯЕМОСТИ	
 SCIVOLISITÀ SKID RESISTANCE - RUTSCHWERT GLISSANCE - ADHERENCIA СКОЛЬЗКОСТЬ	DM 236/89 BCRA	> 0,40		> 0,40 GRIP	> 0,40 NAT
	ANSI A 137.1	WET DCOF > 0,42		> 0,42 GRIP	> 0,42 NAT
	DIN 51130	-		R11 GRIP	R10 NAT
	DIN 51097	-		A+B+C GRIP	-

GEOBRICK

PER I CERTIFICATI SPECIFICI, E VALORI PUNTUALI, CONTATTARE FINOBC SPA - FOR SPECIFIC CERTIFICATES AND DATA, CONTACT FINOBC S.P.A. - FÜR SPEZIELLE ZERTIFIKATE UND PUNKTWERTE, FINOBC S.P.A. KONTAKTIEREN - POUR LES CERTIFICATS SPÉCIFIQUES ET LES VALEURS PONCTUELLES, CONTACTER FINOBC S.P.A. - PARA LOS CERTIFICADOS ESPECÍFICOS Y LOS VALORES CONCRETOS, CONTACTE CON FINOBC S.P.A. - ВО ВОПРОСАХ СПЕЦИАЛЬНЫХ СЕРТИФИКАТОВ И ПОКАЗАТЕЛЕЙ СВЯЖИТЕСЬ С FINOBC SPA.

40 ESCLUSO PEZZI SPECIALI ED ELEMENTI DECORATIVI - WITH THE EXCEPTION OF SPECIAL PIECES AND DECORS - A L'EXCEPTION DE PIÈCES SPÉCIALES ET ÉLÉMENTS DÉCORATIFS - AUSSCHLIEßLICH FORMSTÜCKE UND DEKORTEILE



**RECYCLED
CONTENT**



CE
EN 14411



FINCIBEC S.p.A. socio di :

